

THE PROPERTY OF THE DRAWING IS ESTABLISHED BY LAW. IT IS FORBIDDEN TO PRODUCE OR SHOW IT TO THIRD PART. WITHOUT A WRITTEN AGREEMENT.

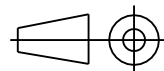
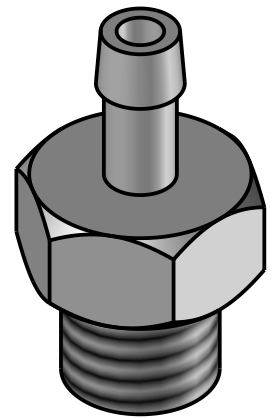
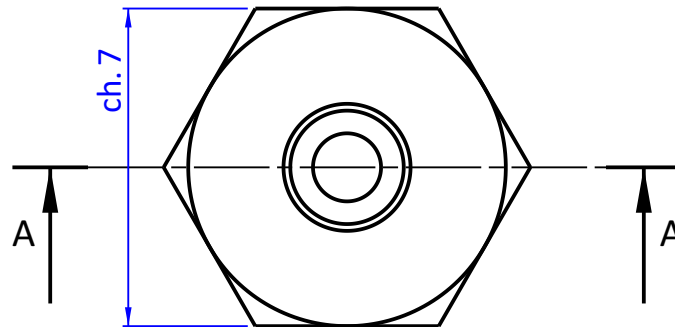
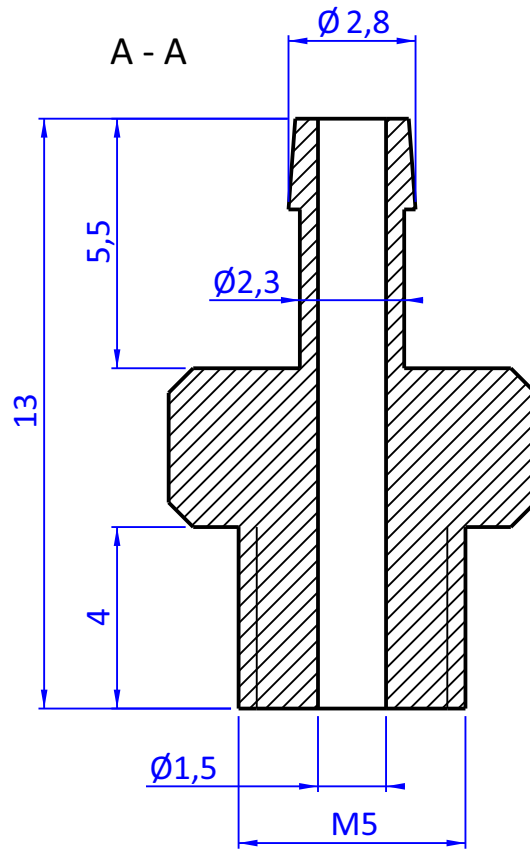

DESIGNED FROM		REVIEW
FPS Automation		A
DATE	WEIGHT	
02/09/2022	0,002kg	
CODE		
CA.08.09.005		

Format A4

UNI 936-76

GENERAL TOLERANCE

UNI - ISO 2768

CLASSE f

DESCRIPTION

CA.08.09.005